

D3-110I-A, D3-130A-A, D3-130I-A, D3-160A-A, D3-160I-A

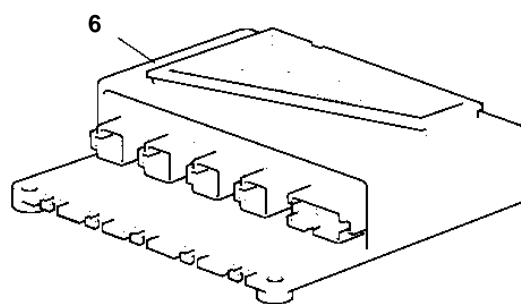
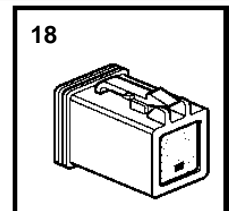
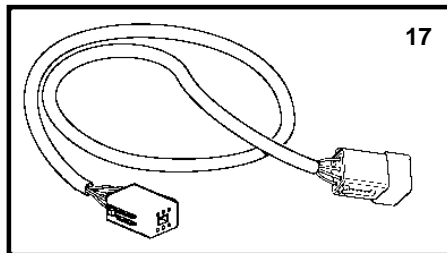
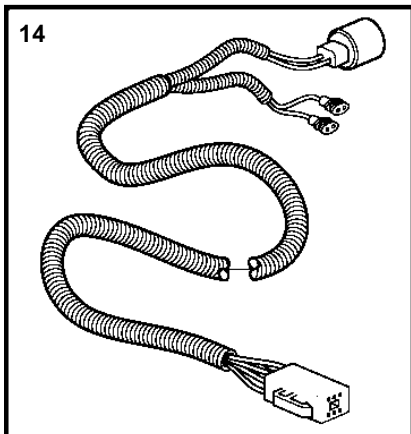
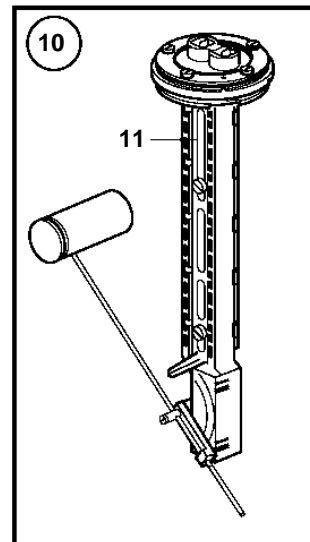
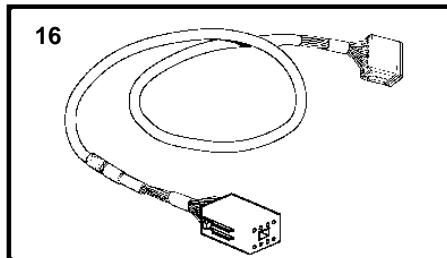
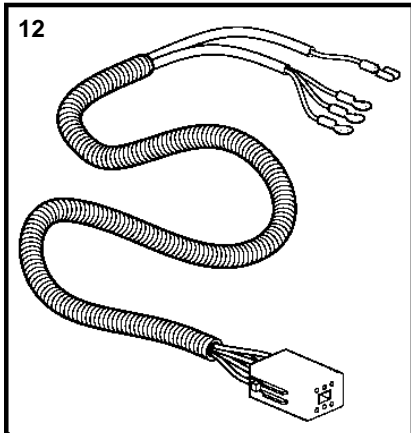
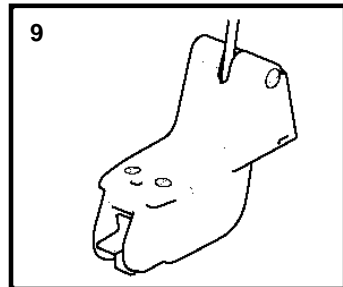
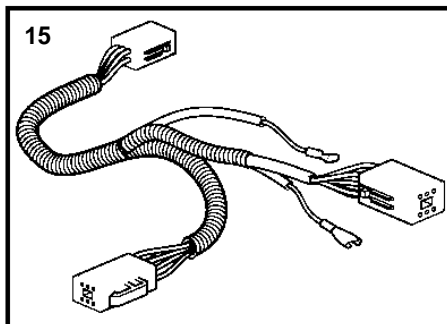
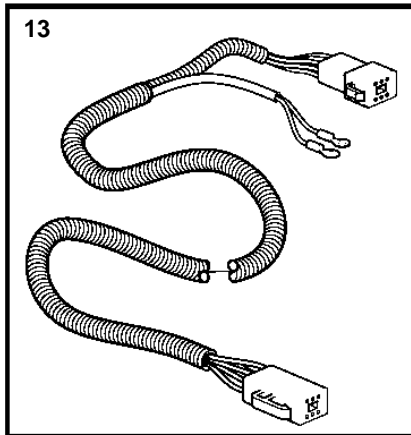
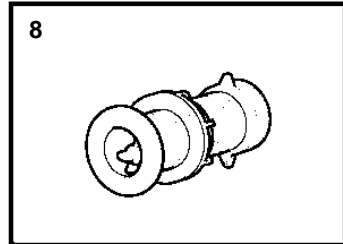
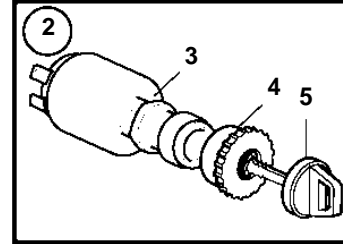
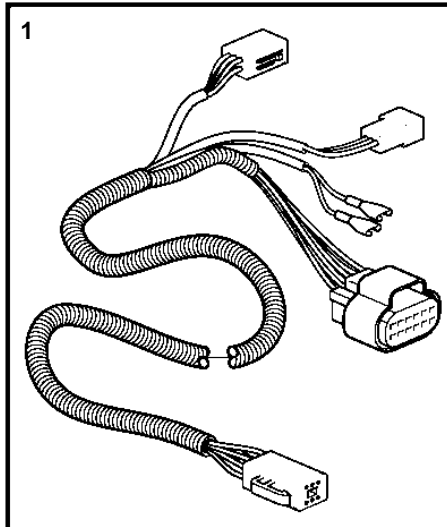
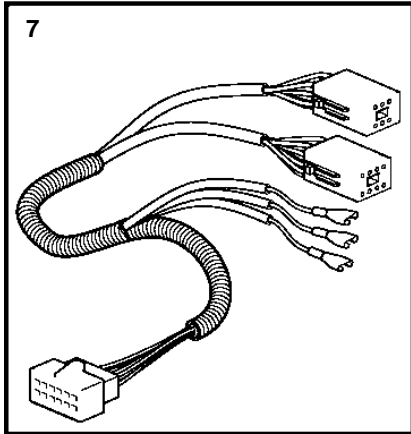

19944

D3-110I-A, D3-130A-A, D3-130I-A, D3-160A-A, D3-160I-A

| REF | PART NO. | QTY | DESCRIPTION | SEE SEC. | NOTES |
|-----|----------|-----|----------------------|----------|--|
| 1 | 881801 | 1 | Wiring harness | | Included in EVC cable kit 3587052., L=2,0m |
| 2 | 3587071 | 1 | Starter switch | | |
| 3 | | 1 | · Starter switch | | |
| 4 | 859955 | 1 | · Plastic nut | | |
| 5 | 859953 | 1 | · Key | | |
| | | | · Bulletin 49-30 | 49-30-EN | Key P/N 859953 |
| 6 | 3807345 | 1 | Control unit | | For SX Drive., HIU |
| | 3807347 | 1 | Control unit | | For reverse gear, HIU |
| | 3589927 | 1 | Software | | Warehouse programming. This p/n can not be ordered, but will be used for invoicing. |
| | 3589926 | 1 | Software | | Vodia-programming. This p/n can not be ordered, but will be used for invoicing. |
| 7 | 881800 | 1 | Wiring harness | | HIU to Engine., Included in EVC cable kit 3587052. |
| 8 | 3587054 | 1 | Kit | | |
| 9 | 3587055 | 1 | Kit | | |
| 10 | 874840 | 1 | Sensor | | |
| 11 | 873772 | 1 | · Tank sensor | | |
| 12 | 881803 | 1 | Wiring harness | | For Trim instrument and Instrument light, Included in EVC cable kit 3587052., L=0.5m |
| 13 | 881802 | 1 | Cable | | For fuel level sender, L=5.0m |
| 14 | 881804 | 1 | Wiring harness | | For trim pump and trim sender, Included in EVC cable kit 3587052., L=5.0m |
| 15 | 881805 | 1 | Cable | | L=0.5m |
| 16 | 888248 | 1 | Extension cable\verl | | Multilink., L=3.0m, 8-way. |
| | 888249 | 1 | Extension cable\verl | | L=5.0m, 8-way. |
| | 888250 | 1 | Extension cable\verl | | L=7.0m, 8-way. |
| | 888251 | 1 | Extension cable\verl | | L=9.0m, 8-way. |
| | 888253 | 1 | Extension cable\verl | | L=11.0m, 8-way. |
| 17 | 3842733 | 1 | Extension cable\verl | | L=3.0m, (888243), 6-Way |
| | 888244 | 1 | Extension cable\verl | | L=5.0m, 6-Way |
| | 3842735 | 1 | Extension cable\verl | | L=7.0m, (888245), 6-Way |
| | 3842736 | 1 | Extension cable\verl | | L=9.0m, (888246), 6-Way |
| | 3842737 | 1 | Extension cable\verl | | L=11.0m, (888247), 6-Way |
| 18 | 3840433 | 1 | Sealing plug | | Plug for connection in HIU when reverse gear is used. |